



www.esbe.se



SERIES VRG130



NO.1 IN HYDRONIC SYSTEM CONTROL



Series VRG131
Series VRG132
Series VRG133

CE
Pressure Equipment Directive 97/23/EC

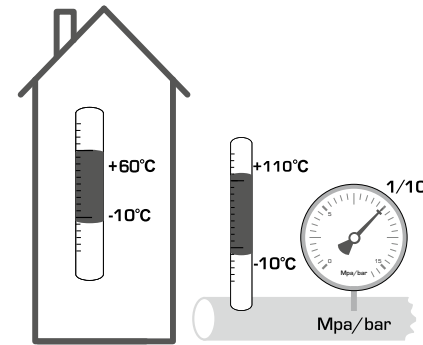

1

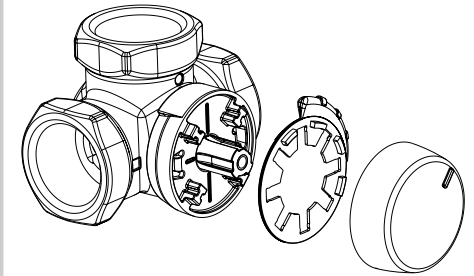

i

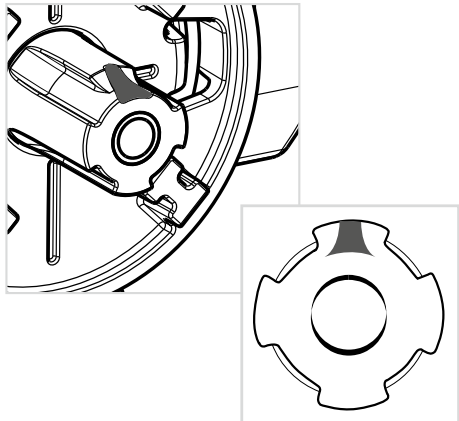

2

a

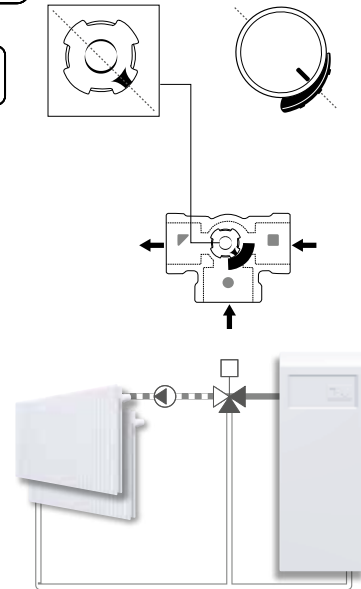

b

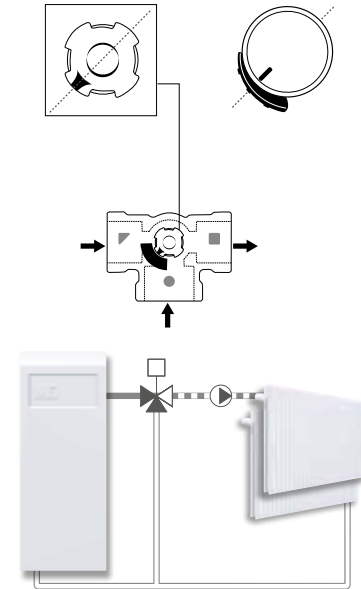

Piping Schematics are General Representations

3

a

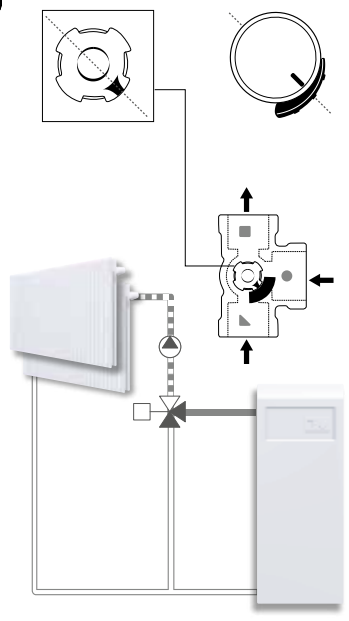

b

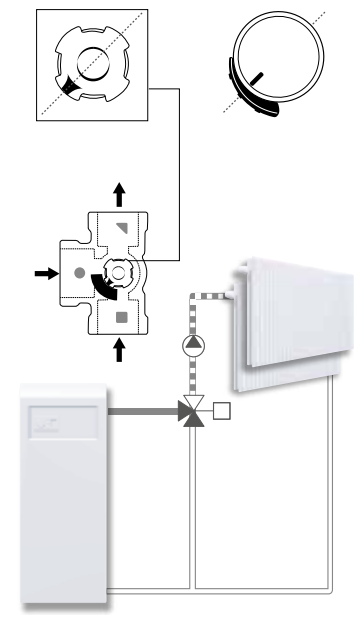

4

a

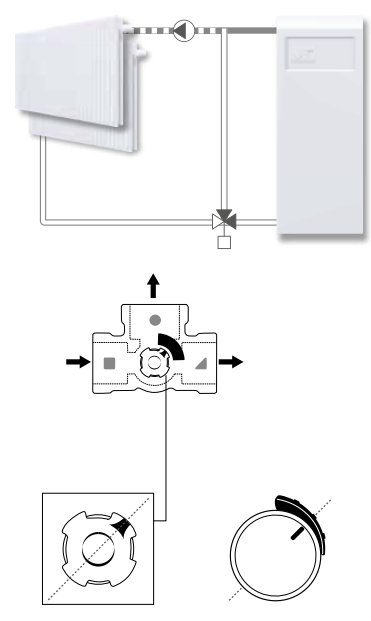

b

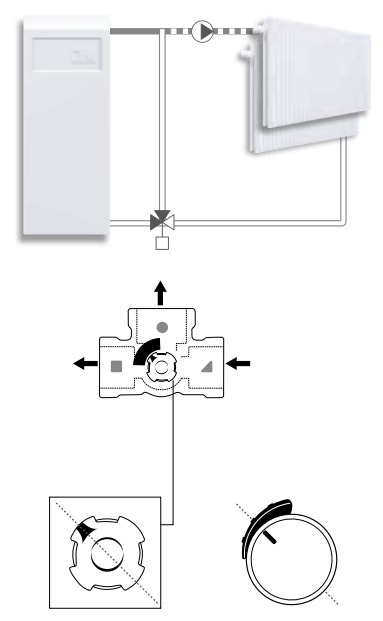

5

a

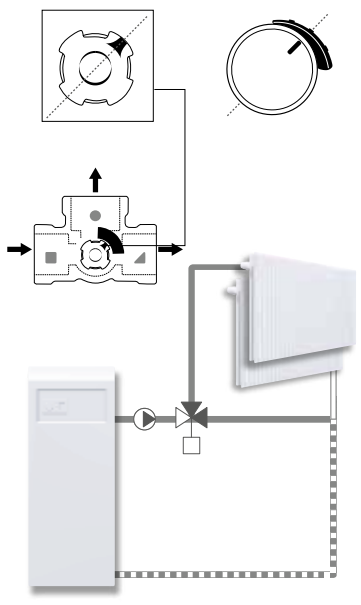

b

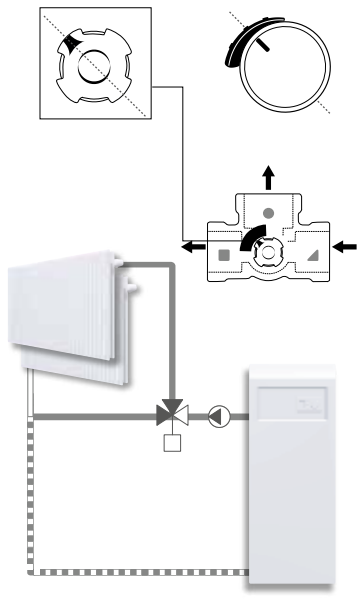

6

a

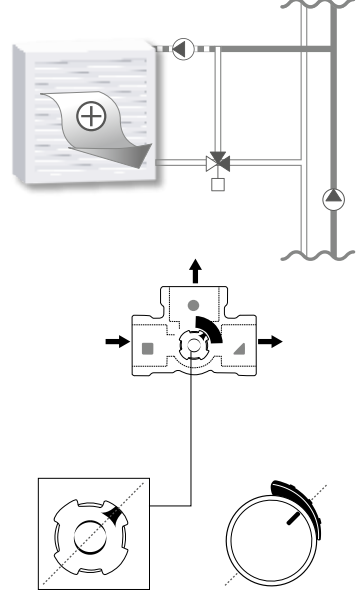

b

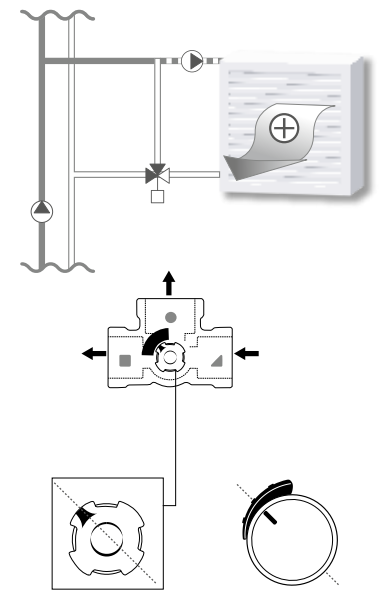

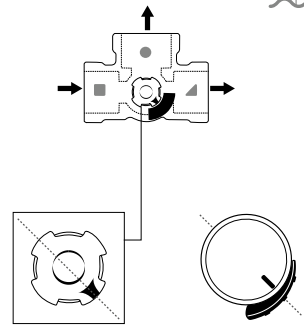
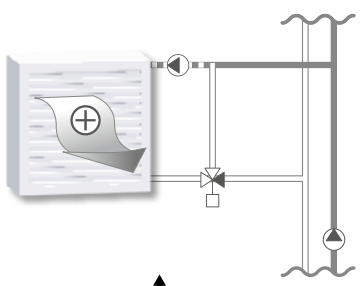
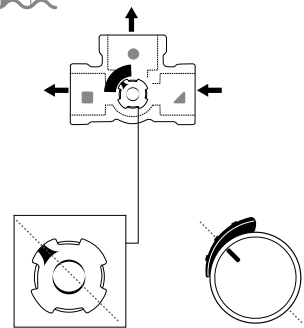
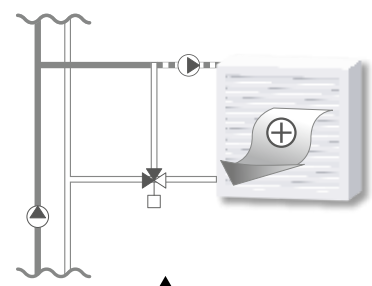
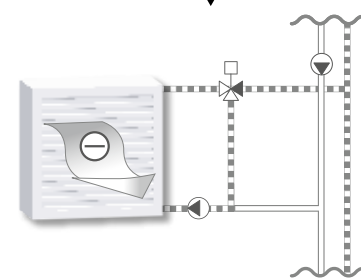
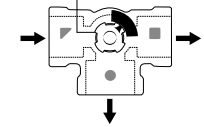
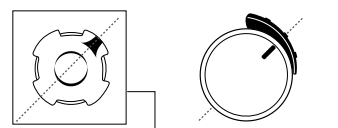
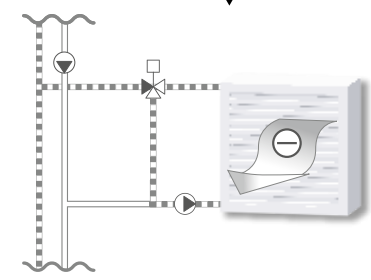
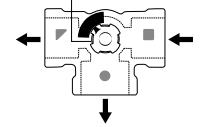
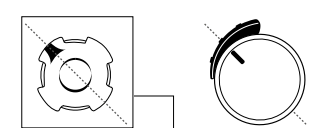
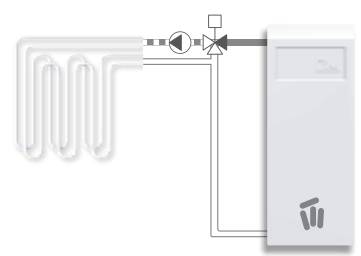
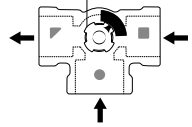
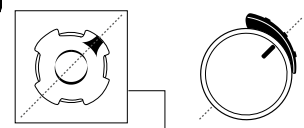
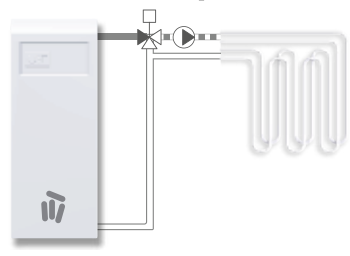
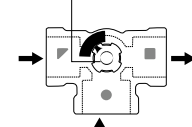
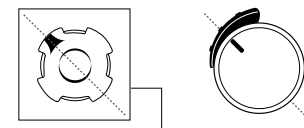
7**a****b****8****a****b****9****a****b****i****SE**

"Denna produkt är anpassad till Branschregler och Säker Vatteninstallation. Leverantören garanterar produktens funktion om branschreglerna och monteringsanvisningen följs."